

SEALING

VIBRATION
CONTROL

CABIN
AIR FILTER



REFLECTING QUALITY IN EVERY COMPONENT

MORE THAN 26,000 SPARE PARTS FOR THE
INDEPENDENT AUTOMOTIVE AFTERMARKET



FREUDENBERG
SEALING TECHNOLOGIES



 Vibracoustic



micronAir®

QUALITY AND SERVICE - IN FOCUS AT ALL TIMES



YOUR PARTNER FOR A NEW AUTOMOTIVE GENERATION

WE DELIVER THE ORIGINAL



a brand of
FREUDENBERG

No matter which products you choose from the Corteco product portfolio, you always receive outstanding original quality. This high-quality standard is directly linked to Freudenberg and characterises our comprehensive spare parts range. Corteco offers more than 26,000 products and service kits to garages – among them leading brands such as the Simmerring® radial shaft seal. Our extensive product program comprises oil seals, valve stem seals, flat gaskets and engine kits, vibration control technology such as engine mounts, pulleys and suspension mounts as well as cabin air filters and brake hoses.

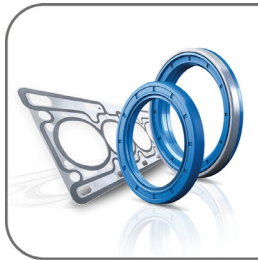

FREUDENBERG
SEALING TECHNOLOGIES



Vibracoustic

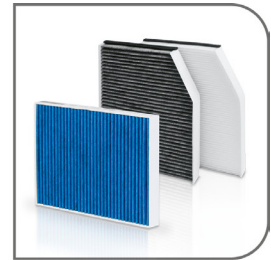

micronAir

FREUDENBERG SEALING TECHNOLOGIES

When it comes to developing automotive sealing solutions for manufacturers of vehicles across the automotive spectrum, Freudenberg Sealing Technologies is the market leader, worldwide. The portfolio has a strong OE pedigree and features almost every style of seal for almost every type of automotive application. It ranges from O-rings and bi-directional, low-friction cassette seals to traditional gaskets.

Vibracoustic

Vibracoustic is the global market leader in the field of automotive vibration control technology. And thus, supplies virtually every passenger vehicle and commercial vehicle manufacturer in the world with components that clearly and noticeably boost the comfort on board. Vibracoustic never focuses on an individual component, but rather on its effect on the vehicle as a whole.

FREUDENBERG FILTRATION TECHNOLOGIES

One of the big challenges facing society today is safeguarding the cleanliness of air and liquids. Innovative solutions are called for. Freudenberg Filtration Technologies develops solutions that make processes more efficient, save resources and protect our environment, thereby raising the quality of life. With almost 60 years of filtration experience dedicated to its customers, Freudenberg Filtration Technologies develops and supplies filtration solutions for surface treatment systems, engine intake air filters and cabin air filters for the automotive industry.



We are inspired by technology and innovation. Together with our customers and with our research partners, we develop leading-edge technologies, products, solutions and services. Having pioneered innovation throughout our history – from chrome tanning and the development of the Simmering to sophisticated and high-tech medical devices – our company is an innovation champion. For us, striving together for solutions that support global sustainability is both our motivation as well as our concept for success. We live “Innovating Together” across business groups and world regions. This enables us to provide our customers with solutions and answers to tomorrow’s questions, today.



SHAPING THE MOBILITY OF THE FUTURE

Freudenberg accompanies technological change in the automotive industry. After all, the future will be driven ever faster by new drive forms. As the world’s leading industry expert with a long-standing and holistic understanding of mobility, we face up to our responsibility to provide our customers with customized products and solutions for a wide range of components in electric vehicles and fuel cell-based vehicles.

For more information check out e-mobility.fst.com



TAKING CLIMATE PROTECTION SERIOUSLY

SUSTAINABILITY AT FREUDENBERG

Sustainability and long-term vision are integral parts of our corporate strategy and social responsibility. Taking action is part of Freudenberg's corporate culture.

In doing so, we follow two approaches. First, we continuously minimize our own **footprint** by using energy and materials efficiently. Second, we maximize our **handprint** by providing sustainable products and services to our customers. Efficient Freudenberg innovations are already significantly reducing the consumption of natural resources and CO₂ emissions in countless customer applications. In short, we are improving both our own environmental footprint and that of our customers.



FOOTPRINT

Less is more

“Footprint” refers to the amount of resources we consume to produce our products and provide our services. The goal is to significantly reduce our use of energy and materials, and to continuously reduce waste, scrap and emissions. That is why we have launched the “Sustainability Drives Climate Action” project. This includes specific targets on how significantly and quickly we will reduce our CO₂ emissions. With energy efficiency projects around the globe, internal CO₂ pricing and the purchase of green electricity, we are sending out clear signals in this direction.

HANDPRINT

The more the better

With innovative Freudenberg solutions, our customers are able to reduce their own resource consumption and emissions. The larger this handprint, the greater the benefit for the environment and customers. Here are just three examples. Low-friction seals have been reducing CO₂ emissions from vehicles for years. Fuel cell and battery systems from Freudenberg enable climate-neutral mobility for ships, trucks and trains. In the machinery sector, our tribological solutions increase efficiency and extend service life, running time and maintenance intervals.



Find out more about **Freudenberg's 4 Steps to climate Neutrality** at freudenberg.com/progressreport/sustainability

INNOVATING TOGETHER

MORE THAN 160 YEARS OF EXPERTISE

1849



Carl Johann Freudenberg establishes tannery in Weinheim. Production of patent leather begins.

1936



Perbunan (synthetic rubber) is used as a sealing material for Simmerrings and replaces leather.

1900



Hermann Ernst Freudenberg develops a tanning process using chrome liquor instead of vegetable products. The company becomes the largest leather manufacturer in Europe.

1957



Trust the Expert

Freudenberg embraces vibration control technology.

1920s



Corte & Cosso established in Turin, Italy.

1960



Involvement with Nippon Oil Seal Industry Company Ltd, Tokyo (NOK) and partnership in Japanese Vilene Company Ltd (also Tokyo) the company becomes a worldwide operating business group.

1932



Trust the Expert

The Simmerring® is developed on the basis of the first seals.

1978



TransTec established, partially owned by Freudenberg & Co.

1936



Agreement with Carl Freudenberg company, distribution of technical leather goods for engines.

1988



Trust the Expert

Particle filter development commences.



1996/97



Corteco brand established in Turin (Italy), Viernheim (Germany) and Lutterworth (UK).

2014



Corteco expands power steering business. Auto Suppliers Ltd acquired by Corteco.

2001



Vibraacoustic created as joint venture between Freudenberg and Phoenix AG.

2016



Corteco - a global company, with focus on partnership, service and quality.

2008



Corteco-Meillor S.A.S. becomes Corteco S.A.S.

2018



„World Automotive Components 2018” award goes to Corteco.

2010



Foundation of Corteco China. Further branches open in Poland, Russia, America and Asia.

2020



Introduction of warehouse automation in Pinerolo (Italy). Corteco's operators and robots work together to assure the best service for customers.

2012



TrelleborgVibraacoustic established as joint venture company for automotive anti-vibration solutions. Corteco India and Corteco Ishino Japan are established.

2021



Corteco opens a new distribution center in Shanghai Chilian (China).



EXPERT IN SEALING TECHNOLOGIES

Corteco is the number one supplier of static and dynamic sealing solutions for after-market applications. As the aftermarket subsidiary of Freudenberg, the world's leading supplier of original equipment sealing solutions, we have all the right credentials.



OIL SEALS (SIMMERRING®)

As oil seals become increasingly more complex, a strong original equipment pedigree allows Corteco to continue to deliver the most comprehensive range of oil seals in original quality to the Automotive Aftermarket.

- ▶ Camshaft
- ▶ Crankshaft
- ▶ High pressure pumps
- ▶ Auxiliary shaft
- ▶ Axles
- ▶ Transmission



VIDEO

How to replace a Crankshaft oil seal distribution and gearbox side for Diesel Engine R9M



OIL SEAL KITS

Corteco sealing solutions in kit form save time and money. They are essential parts for any preventive maintenance program. One set includes all the seals required for a reliable vehicle service.

- ▶ Oil seal kits for timing belt
- ▶ Oil seal kits for clutch
- ▶ Oil seal kits for transmission



OIL DRAIN PLUGS AND WASHERS

Corteco oil drain plugs and washers ensure a fast and simple oil change.

- ▶ Oil drain washer
- ▶ Oil drain plug and washer kits
- ▶ Oil drain plug

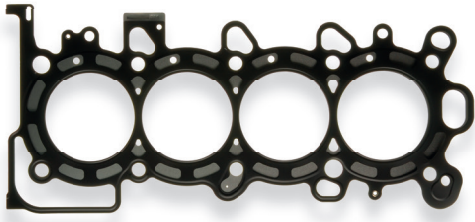

A claims rate below 0.002% on the whole static sealing range confirms **Corteco's high product quality.**

CYLINDER HEAD GASKETS AND HEAD BOLTS

Corteco supplies gaskets featuring a combination of different metals with different elastomer layers, carefully adapted to complement each other and preserve the integrity of the seal. Our range is derived from more than 7,000 gaskets that are available in OEM quality. Corteco gasket engineering follows Freudenberg design standards and enables gaskets to last at least 100,000 km.

Multi-layer steel (MLS) head gaskets are engineered in-house to fit the OE specifications and ensure engine performance and CO₂ reduction.

Head Bolts are the perfect complement to Cylinder Head Gaskets and, when combined, offer the best package for a safe and professional engine repair.

Advantages:

- ▶ Long life durability
- ▶ OE performance
- ▶ Perfect link between Cylinder Head Gaskets and suitable Head Bolts

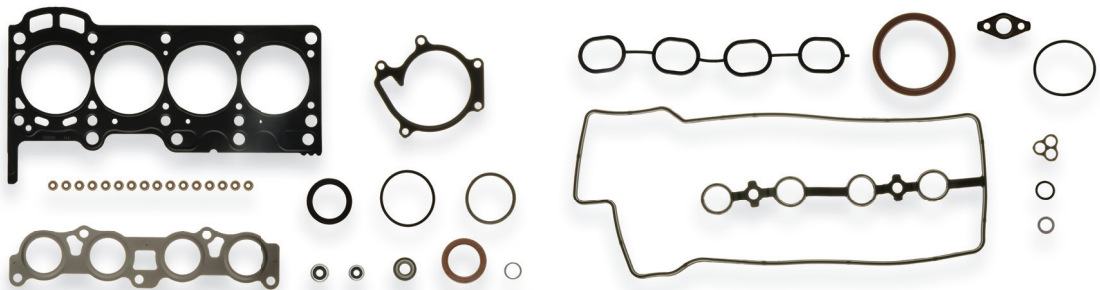

GASKET KITS

Fully equipped gasket kits, Corteco's repair solutions save time and reduce the risk of having to place additional orders resulting in delayed car repairs, blocked car lifts, additional costs, and an overall loss of efficiency. Corteco has added over 400 new gasket kits to its range matching 135 applications.

Advantages:

- ▶ Composition based on direct customer / workshop feedback
- ▶ OE performance
- ▶ Complementarity with Cylinder Head Gaskets and Head Bolts

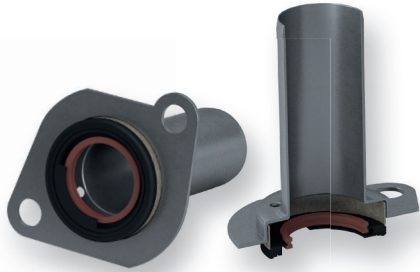

GUIDE TUBES

Guide Tube oil seals have a very important function in a manual gearbox. Its roles are to avoid any leakage of oil from the gearbox to the clutch bell and to make the clutch bearing work properly and in a smooth way.



VIDEO

Find out more about Corteco Clutch Guide Tubes



SILICONE PASTE

Corteco provides a complete range of silicone pastes and consumables for general servicing and maintenance. Whatever the conditions, resistance to high temperatures and protection from oil and water leaks is assured.

In countries where safety regulations permit, Evo300 is also available as a pressure version, Evo300P.



BRAKE HOSES

Corteco supplies the most comprehensive range of brake hoses with pre-fitted brake hose accessories in the aftermarket. All Corteco brake hoses must pass the pressure test at 120 Bar. This test leaves a punching mark on the joint. Only after passing this test the brake hoses can be sold. **Corteco brake hoses fulfill the D.O.T. FMVSS 106 and ISO 9001:2015 regulations.**

It's fundamental to replace both the brake hoses and the brake fluid every 4 years or 80,000 km in order to completely renew the vehicle's braking system efficiency restoring the original performance.



VIDEO

Find out more about Corteco Brake Hoses



INVESTING IN THE FUTURE

CORTECO AND NOK



Corteco, as an affiliate of the Freudenberg Group, enables the Independent Automotive Aftermarket (IAM) to benefit from OE expertise. Thanks to the strong connection between Freudenberg and NOK, Corteco can supply automotive spare parts for Asian applications. NOK is known as an innovative OE development specialist in Asia due to its product knowledge and high-quality standards. NOK is the development partner and leading supplier for Asian OEMs. Corteco unites the expertise from cooperations with all major Asian OE manufacturers and has almost 4,000 sealing products, 2,000 vibration control products and over 250 filters for Asian vehicles in range.

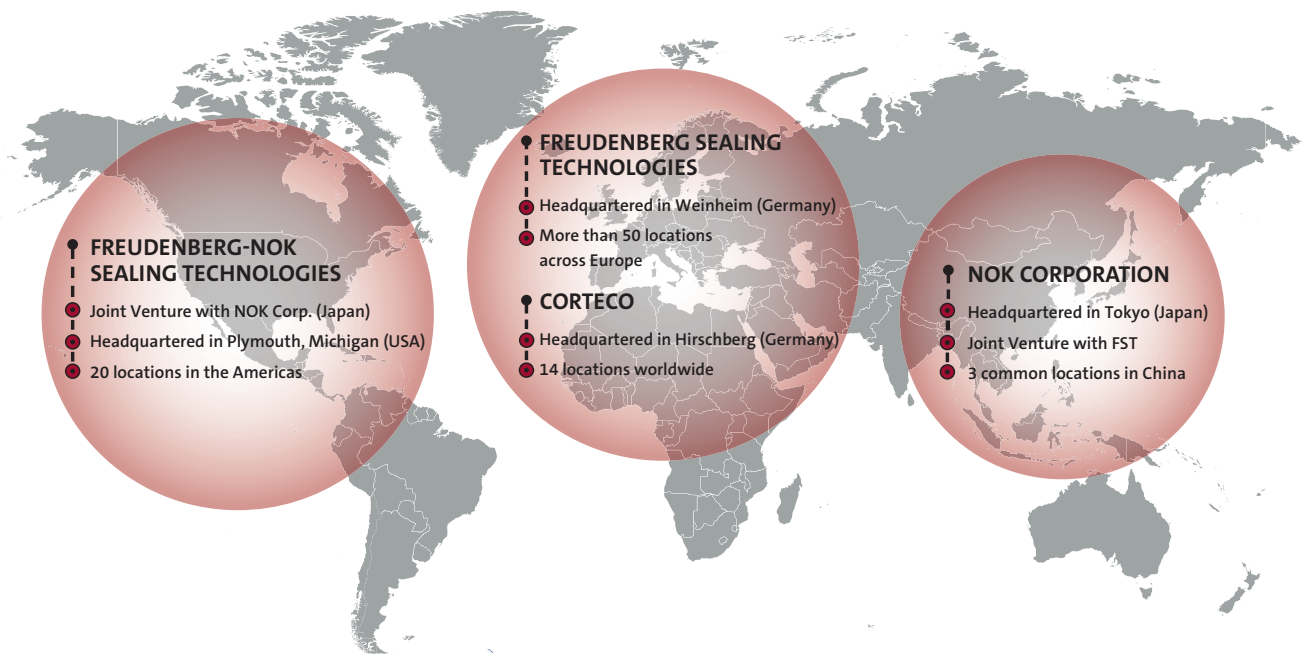

HEAVY DUTY APPLICATIONS IN OE QUALITY

WHEN DURABILITY MATTERS

Heavy duty vehicles operate in difficult environments. Corteco offers seals that are specially designed to withstand external influences such as large amounts of dust and dirt. Corteco Cassette Seals, developed in cooperation with NOK, are the original equipment solutions that fleet operators can rely on. Corteco Hydraulic Kits contain all seals required for a complete system replacement within specific vehicle applications. Installers get everything they need for a repair from one reliable source.

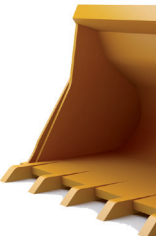

VALVES AND VALVE STEM SEALS

Corteco offers a comprehensive range of Valve Stem Seals that includes almost every sealing option, from those with traditional standard lips to the latest double lip designs.

Valve stem seal with gas-lip technology reduce the “blow-by-effect”.

Advantages:

- ▶ Optimization of oil consumption
- ▶ Significant reduction in exhaust gas emissions



COMPOSITE SEALS

Composite seals with integrated flange are used wherever car and truck crankshafts have to be sealed dynamically.

Advantages:

- ▶ Easy and precise mounting to avoid axial misalignment

CSWS®

Composite seals with integrated sensor.

Advantages:

- ▶ Evolution of the C-SEAL
- ▶ Integrated encoder and sensor to communicate with electronic devices

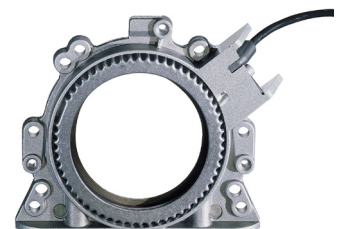

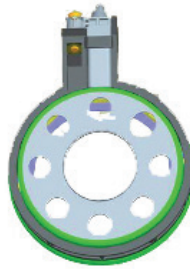

RWDS®

Seal with integrated sensor.

Advantages:

- ▶ More compact than CSWS
- ▶ Lightweight design
- ▶ Easy and precise mounting

ESS® ENERGY SAVING SEALS

Combine PTFE design with FKM (Viton) compound, improving performance and leading to a significant friction reduction.

Advantages:

- ▶ Reduction in fuel and oil consumption, as well as CO₂ emissions
- ▶ Improved dynamic sealing efficiency (visco pump principle)



CASCO SEALS®

Seals with ESS technology integrated into a cassette. CASCO seals generate less friction thanks to the advanced “axial” sealing lip design.

Advantages:

- ▶ Greater control of CO₂ - Lower emission levels
- ▶ Longer lasting, despite extreme working conditions

HYDRAULIC ACCUMULATORS

Hydraulic accumulators are simple but highly effective energy storage devices which are quite often also indispensable safety features. The ability to absorb fluid, retain it under pressure, and release it whenever necessary, has long been used in many vehicle parts such as chassis, suspension, steering or transmission. Hydraulic accumulators are also key components in the support of transmission shifts and innovative electro-hydraulic brakes.





EXPERT IN VIBRATION CONTROL

Vibracoustic is the global market leader in the field of automotive vibration control technology and supplies virtually every passenger vehicle and commercial vehicle manufacturer with components that clearly and noticeably boost the comfort on board. The global R&D network enables the engineers at Vibracoustic to develop unparalleled vibration damping technologies.



CRANKSHAFT PULLEYS

Crankshaft pulleys control the vibrations within the crankshaft. The Corteco product range for crankshaft pulleys includes:

- ▶ Damper pulley
 - ▶ bolt kits
 - ▶ encoder kits
 - ▶ diamond disc kits
- ▶ Decoupled damper pulleys
- ▶ Over 66 pulleys for start-stop engines
- ▶ Over 25 pulley kits for start-stop engines
- ▶ Pulleys for Asian applications

CHECK THE PULLEY WHEN THE BELT IS REPLACED

Vibrations caused by an old or poor-quality pulley can damage the auxiliary units. This can lead to severe engine damage or failure. A simple visual check around the pulley can reveal different types of damage, such as cracks in the elastomer material or damage to the belt. They indicate the need for a replacement of the pulley, an early replacement can prevent subsequent damage.



ENGINE AND GEARBOX MOUNTS

Each rubber mixture has special damping properties and needs to be matched precisely to the specific application. Corteco offers original quality with the highest performance, fitting accuracy and safety.

- ▶ Hydro mounts
- ▶ Switchable engine mounts
- ▶ Lightweight mounts



VIDEO

Find the right part in our online catalog



A COMPLETE RANGE OF STEERING AND SUSPENSION COMPONENTS

Combined skills and the expertise of leading original equipment manufacturers enable a unique range of vibration control parts. Corteco reinforces its vibration control offer of powertrain and chassis components with a large number of Steering & Suspension articles. The range consists of over 7,000 articles, including more than 3,000 Expert Kits and comprises the expertise of the leading Original Equipment Manufacturers.

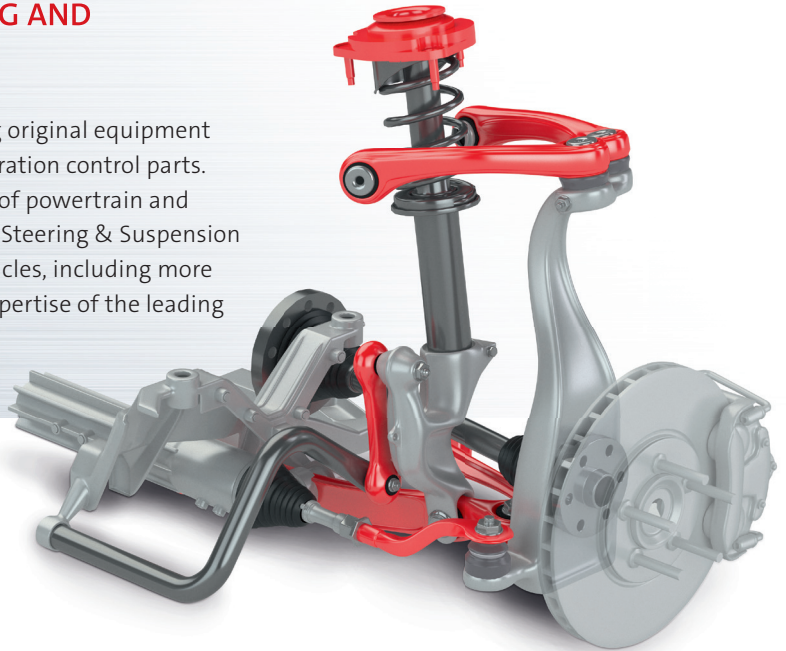

SUSPENSION STRUT MOUNTS

The suspension strut mounts isolate the dynamic forces of the suspension strut and the spring thus avoiding the transfer of vibration to the vehicle body.

- ▶ Strut mounts including ball bearings



VIDEO

Find out more about our steering and suspension range



TRACK CONTROL ARM

Track control arms connect the vehicle chassis and the suspension module that carries the wheel.

Advantages:

- ▶ Ensure quick and precise movement of the wheels
- ▶ Ensure comfort due to vibration damping





CHASSIS AND DRIVE TRAIN MOUNTS

Components such as chassis mounts and bushings play a decisive role when it comes to driving safety and comfort.

- ▶ Stabilizer mounts
- ▶ Drive train mounts
- ▶ Chassis and axle mounts
- ▶ Hydraulic accumulators

STABILIZER LINKS

The stabilizer link controls the body roll of the vehicle during turns by connecting the anti-roll bar and the suspension system of the vehicle.

Advantages:

- ▶ Minimizes noise transmissions
- ▶ Enables safe and comfortable driving



TIE ROD ENDS / TIE RODS

Fixed and adjustable tie rods are the connection between the steering box and the steering wheels of the vehicle.

Advantages:

- ▶ Adjustable to the needs of each individual chassis
- ▶ Ensure accurate steering and safe drivability
- ▶ Reduction of vibration of the steering wheel
- ▶ Reduction of tyre wear

BALL JOINTS

The ball joint is an indispensable component used in tie rods, control arms and stabilizer links.



DRIVING COMFORT YOU HAVE BEEN DREAMING OF

AIR SPRINGS

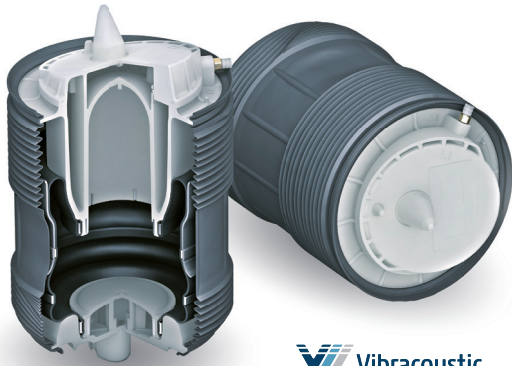

 Vibracoustic

Air springs keep the vehicle at a constant height, regardless of its load. They allow the vehicle to be lowered at high speeds to improve aerodynamics and thus increase range. Switchable air springs offer varying degrees of stiffness, allowing a quick switch between a firm suspension for a confident and safe ride and a more comfortable setting for long journeys.

Air springs also offer a decisive advantage with regard to e-mobility. They optimize the airflow under the car for passive battery cooling in electric vehicles, protect the batteries in poor road conditions and always ensure minimum ground clearance.

Today, almost two thirds of all cars with air suspension are equipped with air springs from the leading air spring manufacturer **Vibracoustic**. These stand-alone air springs are developed and patented for car manufacturers worldwide.

THERE IS NOTHING BETTER THAN THE ORIGINAL PART

ORIGINAL DRIVING SET-UP

Corteco air springs are OE parts and meet the specifications of the vehicle. This exclusively restores the original driving-set up by offering matching air springs for each chassis type (Standard, Sport, AMG, M-Model etc.). Almost all competitors only offer air springs for one chassis type which is an unsatisfactory match.

REPAIR TIME REDUCTION

Corteco offers the possibility to replace only the damaged air spring in order to restore the original driving set-up. Most competitor parts do not match the original manufactured air spring, it is thus recommended to replace them in pairs as they cannot meet OE specifications.

MAXIMUM DURABILITY

All components used to assemble the Corteco air spring module are of the highest quality and new - no wear, no fatigue. They are designed for a service life of approximately 15 years or 300,000 km - based on OE specifications.

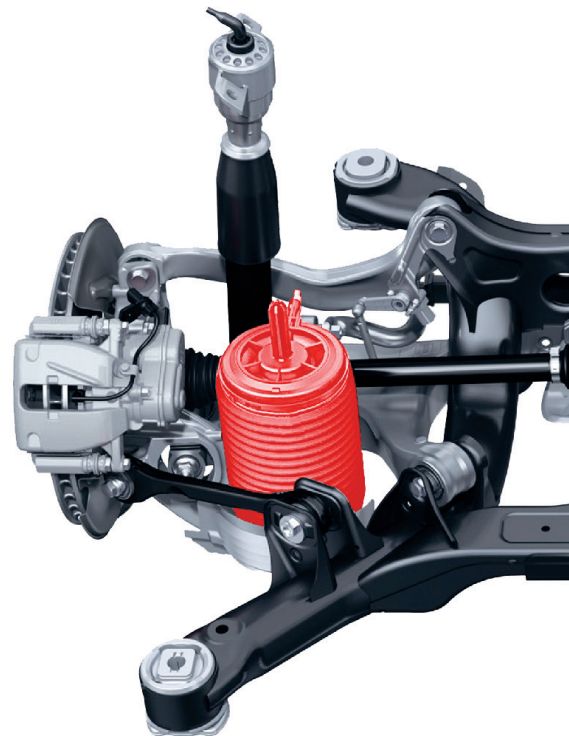



EXPERT IN AIR FILTRATION

Every one in two new cars is fitted with Freudenberg original filters. Corteco offers one of the broadest ranges of cabin air filters for European and Asian applications to its Automotive Aftermarket customers. Each filter is available as a particle and carbon activated version. The range is completed by the innovative Blue Filter, which is highly efficient in protecting the air conditioning system and passengers from external pollutants.



ENGINE INTAKE AIR FILTER

Modern high-performance engines need clean air for peak performance. The atmosphere contains both natural (pollen, dust, sand, etc.) and industrial (soot, abraded materials, pollutants, etc.) contaminants which can adversely affect the combustion process, cause engine damage, and affect the sensors present in modern engines.

Filters for high-performance engines, made from synthetic materials, offer ground-breaking features, such as:

- ▶ Optimum deep-bed filtration with 150% longer service life and improved initial filtration performance
- ▶ Aging resistance and resistance to pressure surge thanks to the use of fully synthetic materials
- ▶ Non-combustible materials offer advantages in the case of fire
- ▶ New processing possibilities thanks to thermoplastic materials
- ▶ Optimum system protection in accordance with ISO 5011

CABIN AIR FILTER EVOLUTION

With the invention of the first cabin air filter back in 1989, Freudenberg Filtration Technologies set a new standard for health protection and safety inside vehicles. The proven micronAir particle filter includes reliable fine dust, pollen, road

dust, soot and bacteria protection. This was later followed by another innovation: the micronAir combi filter. Although the filter media of both micronAir cabin air filters are essentially identical, the micronAir combi filter has an additional layer

of activated carbon to adsorb odors and gases (e.g. benzene and ozone), which in turn is protected by a covering layer. This cabin air filter evolution has now led to the latest addition for the IAM: the micronAir blue cabin air filter.



PARTICLE FILTER

- ▶ Filter out fine dust, soot, exhaust emissions, pollen, bacteria and respirable particles
- ▶ Protect against irritation and health risks
- ▶ Prevent poor visibility caused by fogged-up windows
- ▶ Extend the service life of the entire air conditioning and ventilation system

COMBI FILTER

- ▶ Have all the filtering capabilities of particle filters
- ▶ Provide additional protection against exhaust fumes, unpleasant odors, ozone, benzene and other hazardous gases
- ▶ Combi-filters serve a dual function: health risks are minimized while driving comfort is maximized

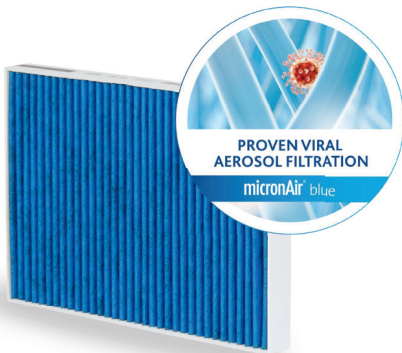

BLUE FILTER

- ▶ Provide the best possible protection against particulate matter, allergens and gaseous pollutants inside vehicles
- ▶ The bio functional layer additionally traps and inactivates the captured viral aerosols and prevents re-aerosolization
- ▶ Significantly reduce the concentration of airborne viral aerosols inside the car

micronAir®



YOUR CUSTOMERS TRUST YOU

YOU TRUST TRANSTEC®

TransTec kits have been synonymous with the highest quality and dependability since the launch into the automotive aftermarket in 1978. TransTec is a brand of Freudenberg Sealing Technologies, the world's largest producer of sealing products. The combined resources of Freudenberg integrate American, German, and Japanese technology to produce state-of-the-art components. Professionals trust the TransTec brand and install these more than all other kits combined.



REBUILD IT WITH THE PARTS THAT BUILT IT

As a brand of Freudenberg the world's largest producer of OE sealing products, TransTec kits feature more of the same components that are supplied to Original Equipment Manufacturers globally than any other aftermarket brand.



YOUR CUSTOMER EXPECTS A COMPLETE REPAIR

Combined with our OEM-culture and expertise, the comprehensive TransTec evaluation process ensures each kit has everything you need to rebuild it right. We know how much each rebuild is worth to your business, and that you can't afford to risk an incomplete, inefficient rebuild or a comeback because you didn't have the parts to rebuild it right the first time.



CHANCES ARE IF WE DON'T HAVE IT, NOBODY WILL

With a 92% vehicle application coverage — the broadest in the industry — there is a TransTec kit for more applications than any other brand on the market.



WORLD CLASS PROCESS FOR TAILORED SOLUTIONS

Our world-class processes, ISO 9001 Certified facility, and management practices allow us to deliver custom-tailored solutions for volume rebuilders.



TECHNICAL & PRACTICAL INDUSTRY EXPERTISE

Our practical experience as master technicians, our automotive aftermarket experience, and the technological and manufacturing resources of Freudenberg give the TransTec team the most comprehensive industry expertise of any brand on the market.



AUTOMATIC TRANSMISSION

TransTec kits feature world-class transmission components produced by our parent company, Freudenberg Sealing Technologies. These are the same components we manufacture as original equipment for every major automotive manufacturer in the world, so quality and dependability are second to none.

For more information about TransTec check out transtec.com



POWER STEERING

Seal kits and components for power steering are available for passenger cars, light commercial vehicles and heavy duty truck applications. We provide sealing solutions for power steering:

- Pumps
- Rack and Pinion units
- Steering gearbox (light commercial vehicles and heavy duty truck applications)



POWER STEERING KIT CONTENT

Each kit contains all components necessary to professionally reseal a power steering pump, rack and pinion or steering gearbox assembly. OEM seals and complimentary components matching the material, durometer and dimensional specifications of the OEM.

- O-rings
- Inner and outer bellow clamps
- Paper, metal and edge bonded gaskets
- Molded elastomeric gaskets
- Low, medium and high pressure shaft seals
- Seal and bulkhead retainers
- PTFE piston, valve, transfer line & port sealing rings
- Prevailing torque pinion locknuts
- Dirt and dust covers
- Plastic bushings
- Tie rod lock plates

Each kit is packaged in a TransTec branded poly bag, labeled with the corresponding TransTec, ASL and Corteco part numbers, basic application information, country of origin and date of production.

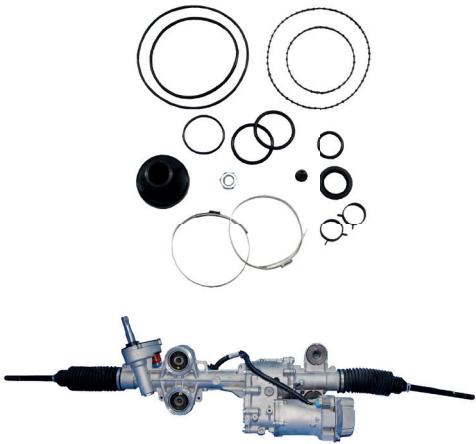

EPS - ELECTRIC POWER STEERING

Electric Power Steering (EPS) is an integral part of advanced stability control systems, and enables advanced driver assist systems like side-wind compensation, lane assist and parking assist systems. EPS systems provide the convenience of assist without the cost in engine size, fuel consumption, and carbon dioxide emissions.

- Hybrid vehicles require EPS as the engine is off at idle
- Steering feel is enhanced by the steering responses EPS provides to the driver
- The same unit can be used on a number of different vehicles with each model having its own level of assist

HEAVY-DUTY POWER STEERING KITS

The new range of TransTec kits seals the market void for independent remanufacturers of power steering units in the heavy duty commercial vehicle sectors around the world.

As an aftermarket brand of Freudenberg Sealing Technologies - which is already an OE manufacturer of sealing components for most of the OE unit manufacturers, TransTec kits have a strong OE pedigree.

The new range is a direct response to a growing market trend among the OE component manufacturers and TransTec continuing the supply of kits and spare parts for OE brands.

As a leading supplier in the Independent Aftermarket, TransTec offers the most comprehensive range of Heavy Duty kits, including applications such as TAS, ZF Series, and Mercedes LS-Series.



TransTec heavy-duty power steering kits benefit the market and its customers:

- Product is available first-to-market
- TransTec power steering kits contain Nylon sealing rings as per the OEM seal kit
- Higher performing material in extreme heat
- More flexible material
- Customized (engineered) solutions can be developed for specific customer needs
- OE quality or better
- Each kit has a more universal usage
- Full technical support and after sales service

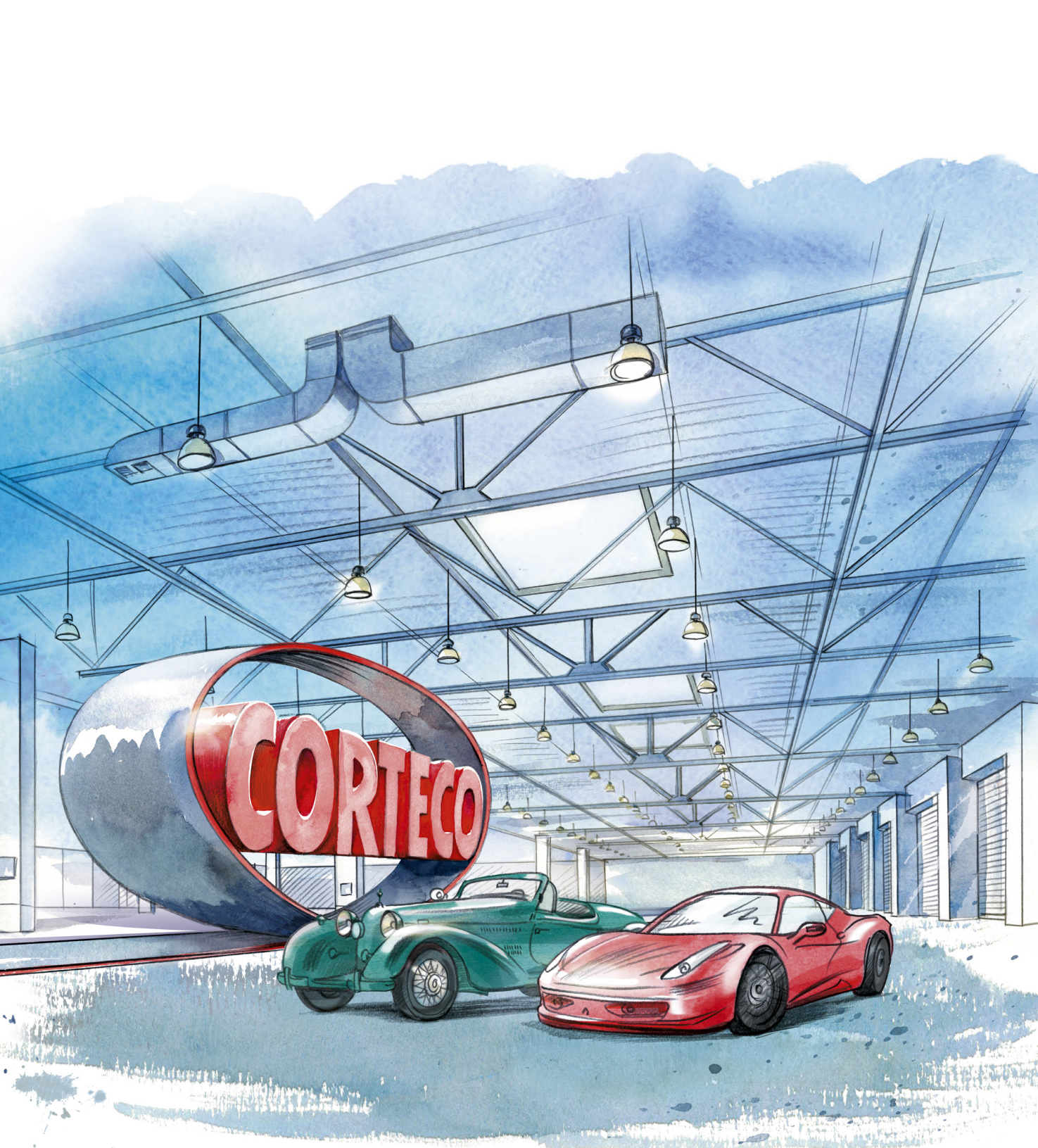

CORTECO AROUND THE WORLD

Corteco has locations in over 15 different countries, but through the Freudenberg Group, we reach customers in 60 countries around the world.

Find the right contact for your market at corteco.com

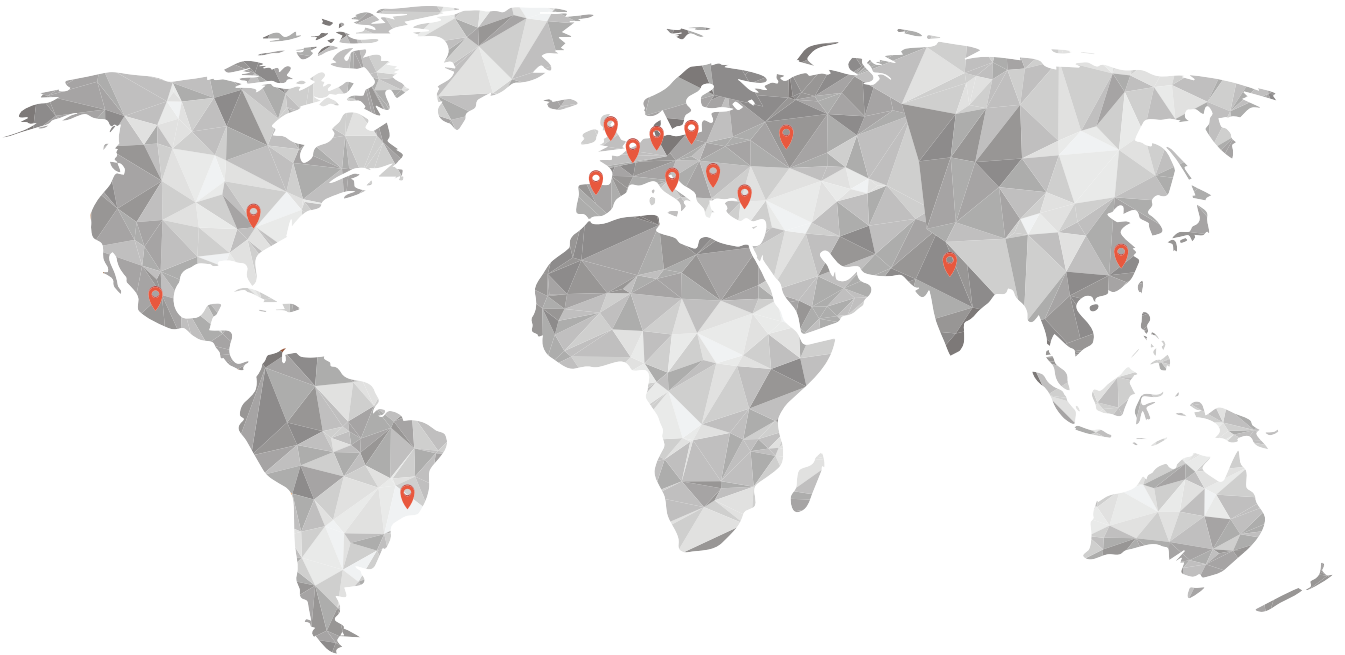

FIND OUT MORE ABOUT CORTECO:



corteco.com
ecatcorteco.com
findourseal.com